

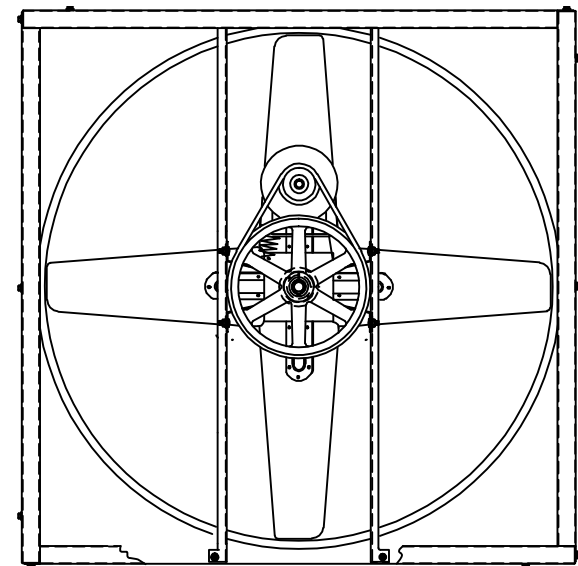

DISCHARGE VIEW

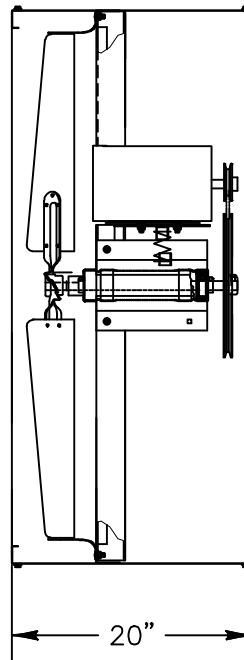

INTAKE VIEW

TRIANGLE ENGINEERING  
CERTIFIED DRAWING

BY:
FOR:
DATE:
VI4214 WALL FAN, 3/4 HP 115/230 V.
1 PHASE
BLADE DIA 42"

 TRIANGLE ENGINEERING OF ARKANSAS, INC.	VI4214 WALL FAN	
	L-VI4214	REV
DR. BY: TOM KING	CKD.	APP.
SHEET 1 OF 1	NOT TO SCALE	12 DEC 2003