

DISCHARGE VIEW

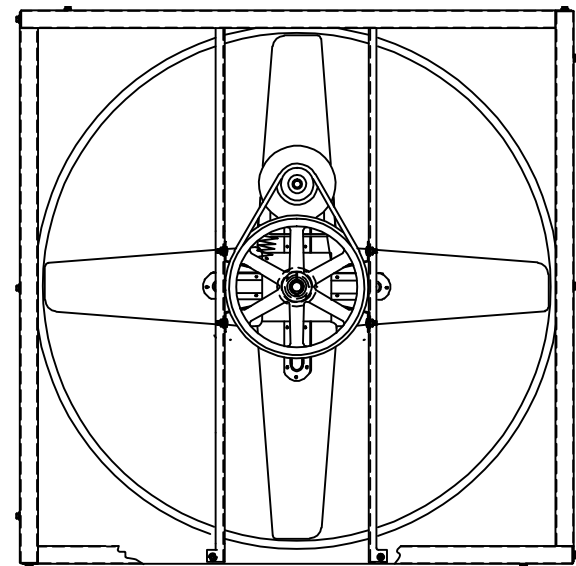
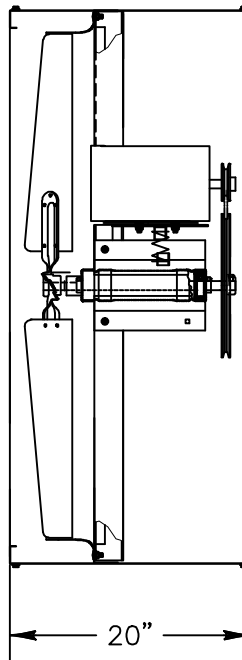

INTAKE VIEW

TRIANGLE ENGINEERING
CERTIFIED DRAWING

BY:
FOR:
DATE:
VI3013 WALL FAN, 1/2 HP
115V, 1 PHASE
BLADE DIA 30"



TRIANGLE ENGINEERING
OF ARKANSAS, INC.

VI3013
WALL FAN

L-VI3013

REV

DR. BY: TOM KING

CKD.

APP.

SHEET 1 OF 1

NOT TO SCALE

17 OCT 2005