

DISCHARGE VIEW

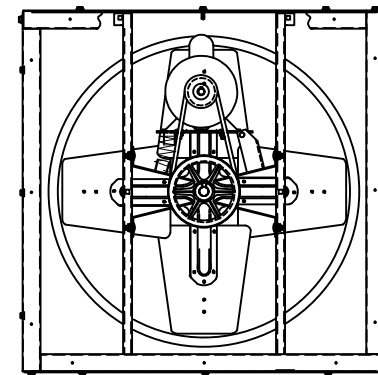
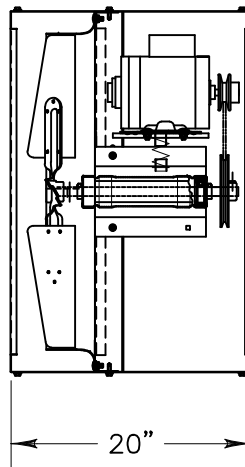

INTAKE VIEW

TRIANGLE ENGINEERING
CERTIFIED DRAWING

BY:

FOR:

DATE:

VI2413 WALL FAN, 1/2 HP

115V, 1 PHASE

BLADE DIA 24"



TRIANGLE ENGINEERING
OF ARKANSAS, INC.

VI2413
WALL FAN

L-VI2413

REV

DR. BY: TOM KING

CKD.

APP.

SHEET 1 OF 1

NOT TO SCALE

31 JAN 2014