

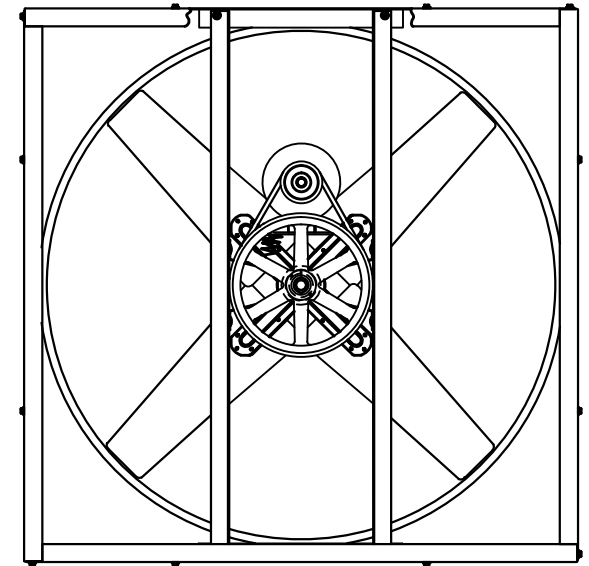

INTAKE VIEW

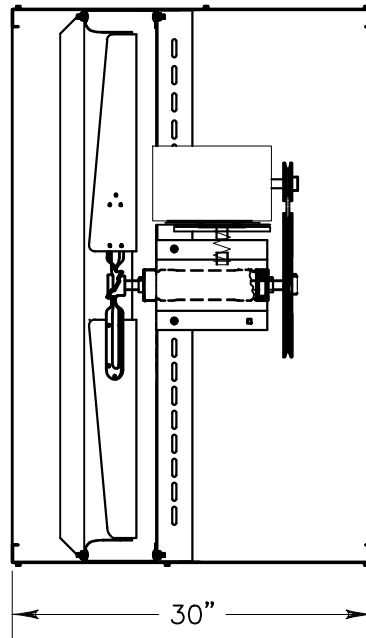

DISCHARGE VIEW

HORSE POWER: 1 1/2  
 VOLTAGE: 115/230V  
 PHASE: 1  
 BLADE DIAMETER: 48"

 TRIANGLE ENGINEERING OF ARKANSAS, INC.	RV14816U WALL FAN	
	RV14816U	REV
DR. BY: TOM KING	CKD.	APP.
SHEET 1 OF 1	NOT TO SCALE	6 OCT 2015