

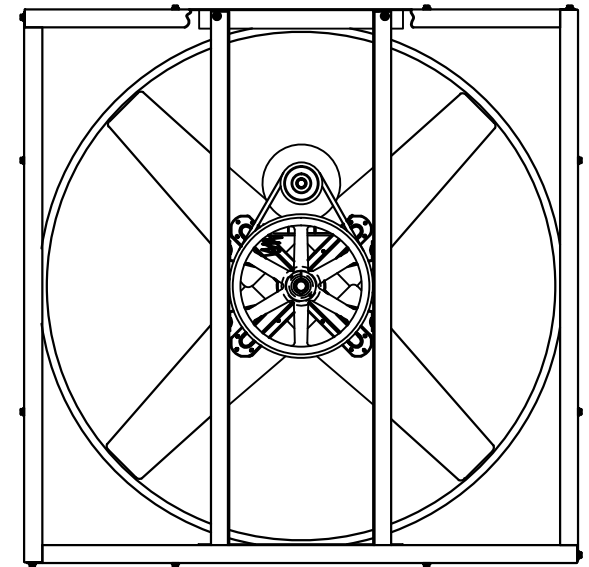

INTAKE VIEW

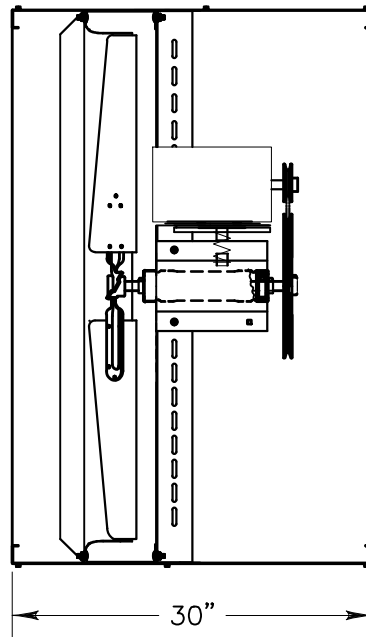

DISCHARGE VIEW

HORSE POWER: 1
 VOLTAGE: 115/230V
 PHASE: 1
 BLADE DIAMETER: 48"

 TRIANGLE ENGINEERING OF ARKANSAS, INC.	RV14815U WALL FAN	
	RV14815U	REV
DR. BY: TOM KING	CKD.	APP.
SHEET 1 OF 1	NOT TO SCALE	6 OCT 2015