

# **SUPERNOVA<sup>2</sup><sub>TM</sub>** **GEARED CHUCK** **MANUAL**

**READ THIS MANUAL CAREFULLY AND  
BECOME THOROUGHLY FAMILIAR WITH  
CHUCK OPERATIONS BEFORE USE**

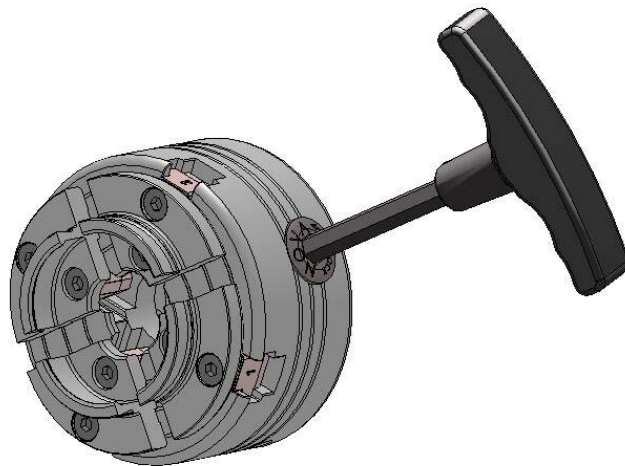

## **Teknatool International Ltd**

65 The Concourse, Henderson, Auckland, New Zealand

Website: [www.teknatool.com](http://www.teknatool.com)

Email: [sales@teknatool.com](mailto:sales@teknatool.com)

Phone: 0064-9-837 6900

Fax: 0064-9-837 6901

© Copyright Teknatool International 2004,2005  
Teknatool Publication No. 106-0502-003 update 22/04/05

## WELCOME

Thank you for purchasing our Teknatool SuperNova<sup>2</sup> Geared Chuck. We are confident it will help to both enhance and advance your woodturning. The Teknatool SuperNova<sup>2</sup> Chuck is a very versatile unit, designed to offer a wide range of workholding modes. The SuperNova<sup>2</sup> has a powerful grip while being quick and easy to use.

It combines the best features of our Nova Chuck, SuperNova Chucks and similar woodturning chucks (wide jaw movement, quick two way grip) with the advantages of the latest technology and innovation from Teknatool.

## BENEFITS OF THE SUPERNOVA<sup>2</sup> CHUCK

- Hard wearing, heavy duty composite indexing backing plate
- Captured pinion with rotation arrow. Makes it easier to use the allen key as it seals easier and faster. Also helps with easy opening and closing.
- Fully backwards compatible with SuperNova and Nova Chuck accessories. The SuperNova<sup>2</sup> Chuck can accept a wide variety of add on accessory jaws – and all accessories are fully interchangeable and compatible (with the only exception of the jaw slides) between all the Teknatool Chucks (Nova, SuperNova, SuperNova2 and Titan Chucks)
- New design woodworm screw locks into the chuck body and provides a strong and durable screw chucking function.
- Faster action than the old SuperNova.
- Ball nose allen key with easy grip plastic handle.
- Seal of authenticity – holographic Teknatool sticker on backing plate.
- New display box has space to display chuck and extra accessory jaws, and insert.

### All Teknatool Chucks have Jaws specifically designed for Woodturning:

All the Nova jaws are specially designed to expand into recesses or contract around round/square wood spigots of varying sizes and applications. Some irregular pieces can also be gripped. Teknatool chucks can swap from the expansion/dovetail mode to the spigot mode and back instantly, with no adjustments or extra fittings being necessary. In modes, any spigot or recess size can be selected between the minimum and maximum range of the jaws. With the add-on accessory jaws removed, the jaw slides can be used to grip quite small spigots.

As a valued customer, we would be pleased to hear from you and how you found your SuperNova<sup>2</sup> Chuck. Any comments on the chuck or accessory ideas would be very welcome so that we can continue to offer what we believe is the best woodturning chucking system available.

**ACCURACY:** The SuperNova<sup>2</sup> Chucks are sample tested from each batch and are made to run within the following tolerance limits:

Face Runout Maximum: 0.1mm (0.0039 inch)  
Radial Runout Maximum: 0.13mm (0.005 inch)

The testing is performed with the chuck mounted on a standard insert. To ensure accuracy when mounted on a lathe, refer to page 6. It is well to note that wood is quite a plastic material - with different densities even in the same piece, and liable to warp out of place while turning. This is a part of the beauty and appeal of working with such a medium. However, under these circumstances pursuing accuracies as quoted above can be very difficult to achieve. For most woodturning situations (with some expectations) there is little need to achieve such tolerances.

## **CONTENTS**

<b>SAFETY Rules</b>	<b>4</b>
<b>Models</b>	<b>5</b>
<b>Exploded Drawing &amp; Parts List</b>	<b>6</b>
<b>Chuck Operation</b>	<b>7</b>
<b>Mounting Chuck on Lathe</b>	<b>8</b>
<b>Fitting Chuck to Lathe</b>	<b>9</b>
<b>Mounting the Jaws</b>	<b>10</b>
<b>Operating Modes</b>	
<b>Screw Chuck</b>	<b>10</b>
<b>Dovetail Operation</b>	<b>11</b>
<b>Forming Recess</b>	<b>12</b>
<b>Spigot Operation</b>	<b>13</b>
<b>Troubleshooting Guide</b>	<b>14</b>
<b>Chuck Maintenance</b>	<b>16</b>
<b>Optional Accessories</b>	<b>21</b>
<b>Warranty</b>	<b>24</b>

## **YOUR SAFETY**

### **IMPORTANT PLEASE READ & UNDERSTAND THIS INFORMATION BEFORE USING YOUR SUPERNOVA<sup>2</sup> CHUCK**

**DANGER: THIS CHUCK IS CAPABLE OF CONTRIBUTING TO SERIOUS INJURY, AS WITH ANY OTHER POWERTOOL ACCESSORY, IF USED IMPROPERLY ON THE LATHE.**

**Before using the SuperNova<sup>2</sup>Chuck, read and understand this instruction manual. Read and understand also the lathe owner's manual. If you do not have a manual, contact the supplier of your lathe to obtain one before using the lathe and Chuck.**

User must be professionally trained to use this chuck. Vocational school courses recommended. As with other chucking methods, an extremely cautious and sensible approach is necessary. With the SuperNova<sup>2</sup>Chuck it is not possible to give exact directions as to the amount of tightening pressure required for workholding. Follow closely strict guidelines in this manual for different jaw types on wood blank diameters and length, plus turning speed.

#### **BEFORE USING SUPERNOVA<sup>2</sup>CHUCK MAKE SURE THAT -**

- ALWAYS WEAR EYE PROTECTION WHICH COMPLIES WITH CURRENT ANSI STANDARD Z87.1 (USA). WE RECOMMEND THAT A FULL FACE SHIELD BE USED AT ALL TIMES.
- Chuck is properly secured on lathe spindle. Follow mounting instructions for your lathe for faceplates and other spindle fixtures.
- For safety, DO NOT ROTATE CHUCK UNDER POWER WITHOUT WOOD BEING GRIPPED.
- **WARNING:** EXCESSIVE SPEED IS A SERIOUS LATHE HAZARD. ALWAYS TURN AT THE SLOWEST SPEED POSSIBLE.
- Speed will vary with wood blank size. The larger the blank the slower the speed. Consult your lathe manual or lathe information plate for speed guidelines.
- DO NOT ATTEMPT TO USE THE CHUCK UNLESS THE LATHE SPEEDS ARE KNOWN, YOU MUST STRICTLY FOLLOW THE MAXIMUM SPEED LIMITS SET OUT IN THE OPERATING SECTION OF THIS MANUAL. DO NOT EXCEED THEM UNDER ANY CIRCUMSTANCES.
- EXAMINE WOOD CAREFULLY. ONLY MOUNT WOOD THAT IS SOUND, If any cracks, splits, or weakness is found in wood - DO NOT MOUNT ON CHUCK. DO NOT MOUNT ANY WOOD THAT IS LIKELY TO BREAK UP DURING TURNING (E.G. ROTTEN OR SPONGY WOOD). DO NOT USE POORLY JOINTED/LAMINATED WOOD.
- Make sure wood is clamped firmly. Follow mounting instructions for different gripping modes and jaw types. In the expansion mode do not use undue force or jaws may split the wood.
- Do not exceed maximum guidelines in this manual for wood blank diameters/length set out in this manual for different modes and jaw types. **DO NOT USE WITH ANY COPYTURNER**

#### **OPERATIONS**

- Check wood is securely held in chuck, before operation. Check grip by vigorously wrenching wood blank back and forth. If any loosening occurs, re-examine holding area for adequate grip (Following mounting guidelines) and any damage to holding area. Rotate manually to make sure of clearance before switching power on.
- WARNING FOR SAFE OPERATION. DO NOT EXTEND JAW SLIDES BEYOND CHUCK BODY UNDER ANY CIRCUMSTANCES. ONLY OPERATE CHUCK WITH JAW SLIDE STOP SCREW IN PLACE AND TEST TO MAKE SURE IT IS ADJUSTED OUT TO STOP JAW SLIDE.
- This prevents jaw slides from dislodging from chuck.
- Irregular or out of balance stock needs to be turned at the slowest possible speed until it is in balance. For use on outboard/left-hand rotation - MAKE SURE INSERT IS SECURELY LOCKED WITH GRUBSCREW BEFORE USE. Use only hand held woodturning chisels to shape wood being held in chuck.
- USE THE RIGHT CHISEL FOR THE JOB AND DO NOT FORCE TOOLS. Use safe and commonly approved chisel techniques. **Wherever possible stand to one side of the revolving wood.**

- **WEAR PROPER CLOTHING.** Do not wear any loose clothing, neck ties, gloves, bracelets, rings or other jewellery that could get caught in moving parts. Wear protective hair covering to contain long hair.
- **DRUGS, ALCOHOL, MEDICATION.** Do not operate chuck or lathe while under the influence of drugs, alcohol or any medication.
- **KEEP CHILDREN AND VISITORS AWAY.** All children and visitors should be kept safe distance from the work area.

**Make workshop childproof with padlocks, master switches, or by removing starter keys.**

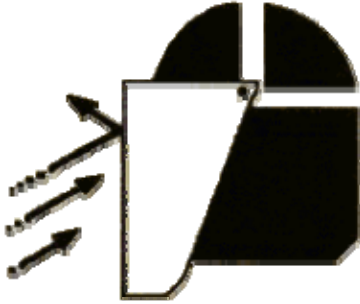

**Teknatool promotes safety Wear a face shield**

## **SUPERNOVA<sup>2</sup> MODELS**

There are two models of the SuperNova<sup>2</sup> Chuck designed to meet various woodturning requirements. Please check the contents of your box to ensure you have model you intended to purchase.

Note that inserts, accessory jaws etc are fully interchangeable between the Nova, SuperNova, Titan and SuperNova<sup>2</sup> Chucks. The only except is the jaw slides which are not interchangeable between the SuperNova<sup>2</sup> and older model chucks.

### **STANDARD MODEL (SKU# 23055)**

**Standard Accessory Kit:** 1x Chuck body, 1 x 50mm Jaw Set, 1x M6 Grubscrew, 2 x Fibre washers, 1 x Allen End Pinion handle, 8 x M6x10 Jaw screws, 1 x SuperNova<sup>2</sup> Chuck Quick Start Manual (sheet)

### **75mm BOWL JAW MODEL (SKU# 23056)**

**Standard Accessory Kit:** 1x Chuck body, 1 x 50mm Jaw Set, 1x M6 Grubscrew, 2 x Fibre washers, 1 x Allen End Pinion handle, 8 x M6x10 Jaw screws, 1 x SuperNova<sup>2</sup> Chuck Quick Start Manual (sheet)

## SUPERNOVA<sup>2</sup> CHUCK EXPLODED DRAWING & PARTS LIST

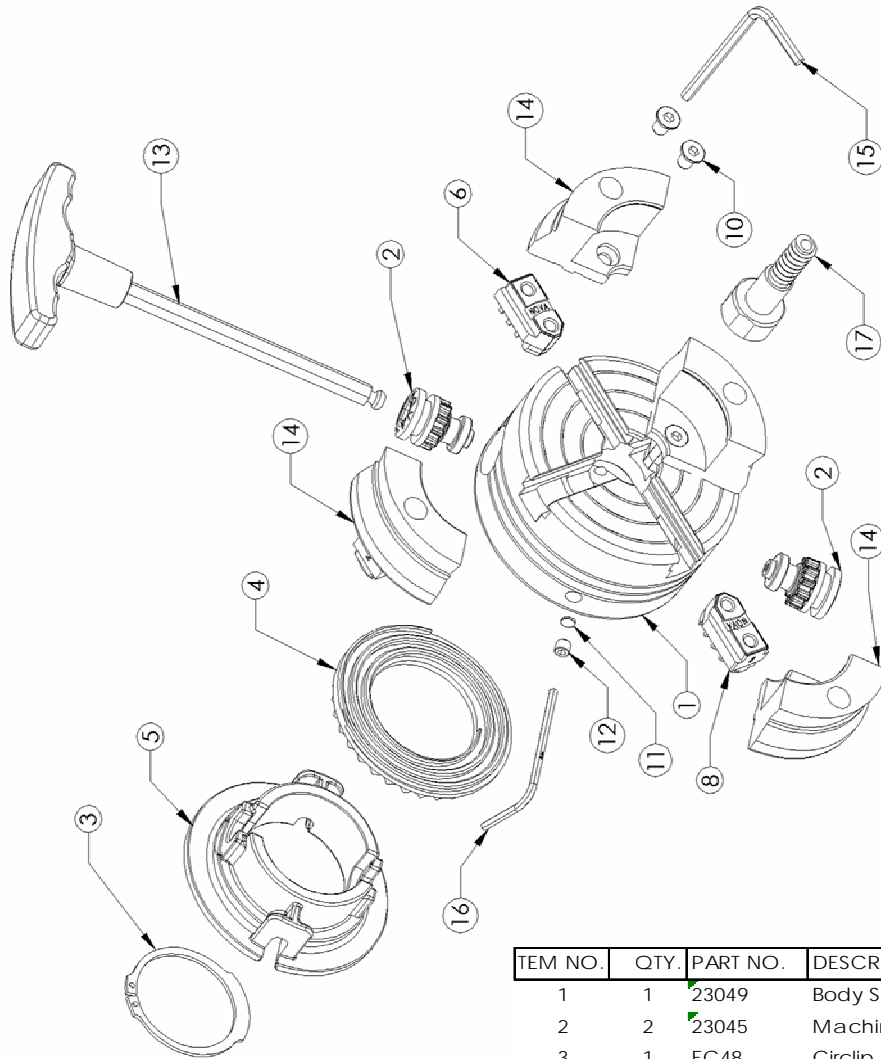

ITEM NO.	QTY.	PART NO.	DESCRIPTION
1	1	23049	Body SuperNov a 2
2	2	23045	Machined Cast Pinion
3	1	EC48	Circlip
4	1	23044	Machined Cast Scroll Rin
5	1	23048	Plastic Backing Plate
6	1	23051	Jaw Slide 1
7	1	23052	Jaw Slide 2
8	1	23053	Jaw Slide 3
9	1	23054	Jaw Slide 4
10	8	CM5010180	Screw C/Sunk
11	2	NS1000	Washer Fibre
12	1	G0606	Grubscrew
13	1	13006	Handle
14	4	6013	Jaw Segment
15	1	AK4	Allen Key 4mm
16	1	AK3	Allen Key 4mm
17	1	WWCJ	Woodworm

## CHUCK OPERATION

Adjustment: A handled chuck pinion key is provided for adjustment of chuck action. Please refer to the exploded drawing on page 6 for location of the two key positions.

### **TO OPERATE JAWS:**

Insert the Allen key into one of the two 22mm guide holes in the SuperNova<sup>2</sup> body. Ensure the Allen key is sitting firmly into the slot - if not engaged properly tightening power will be reduced and could result in damage to gear teeth.

### **TO CONTRACT JAWS:**

**Turn the handle in an anti clockwise direction to contract the jaws. The direction to tighten the jaws is shown on the directional arrow.** When the action takes up against the piece held give an extra nip up so jaws securely engage with wood.

### **TO EXPAND JAWS:**

**Turn the handle in a clockwise direction to expand jaws.**

When the action takes up against the piece held give an extra nip up so jaws securely engage with wood.

## MOUNTING CHUCK ON LATHE

There are two versions of the SuperNova<sup>2</sup>Chuck: an insert version for all threads up to 27mm (1 1/8") and threaded versions for dedicated threads up to 38mm (1 1/2").

CORRECT MOUNTING OF CHUCK TO INSERT (WITH INSERT VERSION) AND LATHE SPINDLE IS VERY IMPORTANT TO ACHIEVE ACCURACY.

**INSERT VERSION:** Check that the correct insert has been supplied to match your lathe spindle thread. The code of the insert is on a label on the plastic insert cover and stamped on one of the flats of the hexagon section of the insert.

A list of thread sizes that can be fitted with an insert plus the larger dedicated threads is provided below. If you find your lathe thread is not listed, check with your supplier (or [www.teknatool.com](http://www.teknatool.com)) to see if there have been more recent additions to the thread range. Failing that, you may have a blank insert or blank chuck machined to your requirements at an engineering shop in your area.

WE STRONGLY RECOMMEND THAT THE CHUCK IS NOT USED ON LATHE SPINDLES UNDER 16mm (5/8").

### Threads covered by the Insert System (Threads up to 28mm (1 1/8"))

Insert 2 (12NS) : M20 X 2 Tyme Cub  
Insert 3 (13NS) : M20 x 1.5 Electra Beckum Multico Sumaro  
Insert 5 (15NS) : 3/4" 16TPI UNF RH 1/8" spigot  
Insert 6 (16NS) : 3/4" Plain Bore  
Insert 7 (17NS) : 1 1/8" UN RH  
Insert 8 (18NS) : 7/8" 12 UN Left-hand  
Insert 9 (19NS) : 3/4" 16TPI UNF RH 6mm register  
Insert A (IANS) : 3/4" 14TPI BSP RH Teknatool (Pre 1986)  
Insert B (IBNS) : 3/4" 14TPI BSP LH Teknatool (Pre 1986)  
Insert C (ICNS) : 1" 10 TPI BSF PH Teknatool Woodfast Durden  
Insert D (IDNS) : 1 8TPI UNC RH General Rockwell Delta Golding  
Insert E (IENS) : 1 1/4" 12TPI RH Myford MLS  
Insert F (IFNS) : 5/8" Pcmarc  
Insert G (IGNS) : 3/4" 16TPI UNF RH Sears Coronet Minor/Minor  
Insert H (IHNS) : 3/4" IOTPI BSW PH Rockwell Homecraft  
Insert I (HNS) : M24 x 3 RH B Line Arundel K600 K450  
Insert J (JNS) : 1 1/8" 12TPI RH Myford Mystro  
Insert K (IKNS) : M18 x 2.5 ELU DB180  
Insert L (ILNS) : 1 1/4" 8TPI UNS RH (for DVR lathes with this thread only)  
Insert M (IMNS) : 1" 10 TPI BSF LH Teknatool Woodfast Durden  
Insert N (INNS) : Blank. Can be threaded up to 28mm (1 1/8")  
Insert O (IONS) : 1 1/4" BSW PH Morton  
Insert Q (IQNS) : M30 x 3.5 RH Teknatool Nova 3000 / Cornet / TL 1500 Woodfast, Vicmarc  
Insert T (ITNS) : 1" 8 TPI LH/RH Dual Threaded, Nova Mercury  
Insert U (1UNS) : 1 1/8" UNF RH Taiwanese  
Insert V (IVNS) : 7/8" 14TPI NF RH  
Insert W (IWNS) : M25x2 RH Tyme Avon  
Insert Y (IYNS) : 1 1/4" 8TPI UNS Teknatool Nova 3000/Comet (USA), Woodfast USA

### Threads Direct to Chuck Body (cannot be changed once cut)

4 Chuck (SNC4) : M33x3.5 RH  
P Chuck (SNCP) : 1 1/2" BSW RH/LH Dual Threaded. Tanner Union Graduate Wackin Bursgreen  
R Chuck (SNCR) : Blank. For threads up to 38mm

### FITTING TO CHUCK:

Check that the internal spigot of chuck body plus insert threads are clean and that the spigot end of the insert is free from damage. Any dents or nicks must be carefully filed off so the insert can be fully screwed home in chuck body. Refer to FIGURE 2. The tolerances of the chuck body and insert are a tight fit to ensure accuracy. This means that the insert may be difficult at first to engage with the chuck body thread. One way is to grip the chuck body in a vice (pad against



damage) and screw in insert using the optional accessory spanner or a 1 1/2" AF spanner. Care needs to be taken that the outer male insert thread is engaged properly at the start with the female body thread. Screw insert fully into body recess. This is important to ensure running. Refer to FIGURE 2.

#### CHUCK INSERT SPANNER:

An optional, accessory insert spanner can be purchased to help wind the inserts into the chuck to remove from the lathe spindle. (Code 23014). See back of manual for further information.

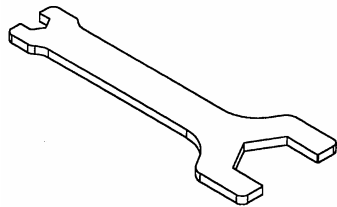

The Insert can now be locked to chuck body by means of the M6 x 6 grubscrew provided. Make sure that the fibre washer is inserted first to act as a buffer between the

grubscrew and insert thread.

**DO NOT SCREW IN GRUBSCREW BEFORE INSERT IS SCREWED HOME IN CHUCK.**

**IMPORTANT: LH THREAD INSERTS MUST BE LOCKED TO CHUCK BODY OR CHUCK BODY COULD UNWIND FROM INSERT.**

### FITTING CHUCK TO LATHE

Correct fitting of chuck to lathe spindle is important to ensure accuracy. The chuck body must contact an accurate shoulder on the lathe spindle or bearings (as on Teknatool Nova 3000) to ensure chuck will run true.

There can be a wide variety of lathe spindle thread and spigot dimensions even within the same thread size. The internal thread size is kept to standard tolerances. The internal thread length and spigots of Nova inserts are manufactured to cover as wide a range of variations as possible. This will mean that in most situations you should be able to get a satisfactory match.

#### CHECK THE FOLLOWING:

Although the insert may screw on part way it may not contact properly with spindle spigot - a spacer or some further modification of the insert may be necessary. This would be the responsibility of the chuck user. Make sure the chuck is screwed to lathe thread properly - a good check is to see whether it screws home on the spindle the same as another lathe fixture such as a faceplate.

**POOR FIT OF CHUCK TO LATHE SPINDLE CREATES A SERIOUS HAZARD WHERE CHUCK COULD DISLODGE FROM LATHE. DO NOT ATTEMPT TO USE CHUCK UNLESS THE CHUCK IS CORRECTLY FITTED TO LATHE SPINDLE.**

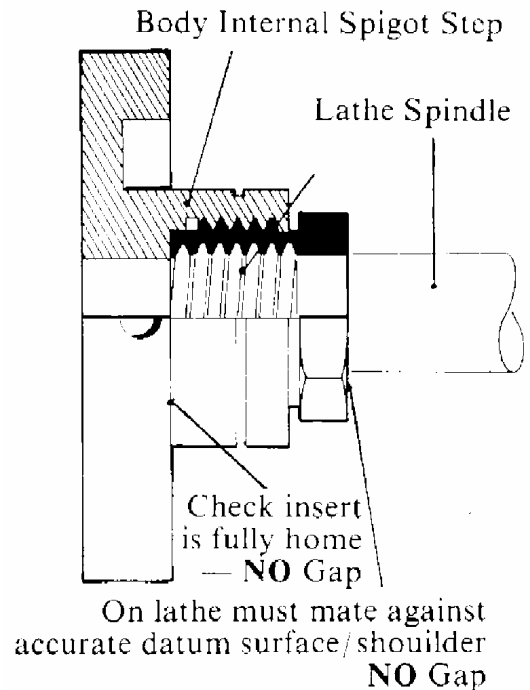

## MOUNTING JAWS

The standard SuperNova<sup>2</sup>Chuck is provided with either 50mm or 75mm add-on jaws. They need to be located and screwed on to the jaw slides of the chuck. The same procedure outlined below must be followed for all accessory jaws as well.

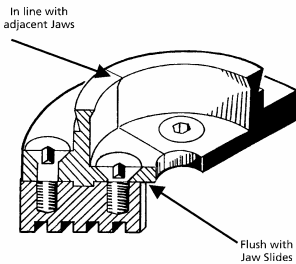

IT IS IMPORTANT TO LOCATE JAWS PROPERLY IN THE JAW SLIDES FOR THE CHUCK TO FUNCTION ACCURATELY. Refer to FIGURE

Follow the method set out below -

1. You will notice that the back of the jaws have a stepped location ring. This location ring is designed to fit into the grooved section of the jaw slide for precision location. Ensure that the slide and collet back are clean and free from any burrs or damage that might affect location. Place the jaw segment over the hole positions on the jaw. Press the jaw segment firmly onto the jaw slide. For the first few times you may need to GENTLY tap the jaws into the locator slot with a block of wood.
2. The screws can now be screwed in, using the 4mm Allen Key provided. Lightly grease or oil screws under each head and on the threads before use to prevent the screws from seizing in the jaw. Preferably use an anti-seize compound e.g. ROCOL J 166 Anti-Seize Compound. Do all screws up finger tight and then back them off one quarter to half a turn.
3. Wind the mounted jaws into the centre of the chuck until they all butt against the other. Now finally tighten screws, starting with centre screws and then outside screws. Nip screws up firmly but DO NOT OVERTIGHTEN.
4. Check there is no light between jaw slides and add on jaw segments or that one or more segments is not higher or lower than the rest. If this is the case repeat procedure above.

## OPERATING MODES

### SCREW CHUCK

This is a convenient mounting method. The woodworm screw is purpose-designed for screw chucking. It is a cylindrical screw which maintains its full holding power along the whole length, unlike normal tapered screws. The thin thread form is specially designed to cause minimum damage to wood fibres. They grip better than screws with thicker threads because there is a larger volume of undamaged wood retained within the screw.

The woodworm screw is made complete with the boss section in one piece. The woodworm screw is designed to be used with the 50mm jaws remaining in place on the chuck. This facility is very convenient for remounting work directly onto the jaws after the screw is removed.

To convert to this operation, place the boss section into the centre of the chuck making sure flat

shanks are aligned to the jaw slides and close jaws around it. BEFORE FINAL TIGHTENING MAKE SURE THAT THE FRONT OF THE BOSS SECTION OF THE SCREW IS SEATED BEHIND AND AGAINST THE 50mm JAWS. This will prevent any tendency for the boss section to creep forward when the screw is being used.

The front face of the 50mm jaws has been machined to provide an accurate backing surface. This is quite an advantage, providing a much tighter fit and better tolerance for irregular face stock. This feature is also quite an advantage when using the screw to mount a bowl for first stage bowl turning - forming the outside of the bowl straight onto the jaws (the screw is first removed) after the recess has been formed.

**SCREW DEPTH:** The screw provides 19mm (3/4 inch) of thread beyond the 50mm jaws. With all wood blocks over 150mm (6 inches) in diameter the full thread depth of 19mm should be used. Irregular, rough tree blanks (e.g. small sections of tree limbs) not exceeding the above sizes can be held quite firmly BUT caution must be exercised. Check for adequate contact.

**CAPACITY:** DO NOT USE THE SCREW FOR VERY LARGE WOOD BLANKS. Its use is intended for small bowl and screw chucking work. The maximum capacity which should be mounted on the screw - 250mm (10 inches) diameter x 100mm (4 inches). DO NOT EXCEED 600 RPM FOR THIS OPERATION. Use tailstock support.

**PREPARATION:** The 10.5mm thread requires a drilled hole about 8mm (5/16") in diameter. The screw has considerable holding power and it is sometimes difficult to unscrew, so wax or oil the thread before mounting the wood.

**CARE:** The threads are fine and can be damaged by mishandling. DON'T hammer into wood! DO screw into a pre-drilled hole. Any nicks on the threads can be removed by careful filing.

## DOVETAIL OPERATION

Expansion of the jaws into a recess. This function is for bowl and platter turning where the projection (depth) of the wood blank is not too great i.e. up to 100mm (4 inches). Characteristically these items have a parallel wood grain. IT MUST NOT BE USED FOR ANY LONG WORK (OVER 100mm) AS THERE WOULD BE GREAT DANGER OF WOOD TEARING OUT AND DISLODGING FROM CHUCK.

Instructions below apply to the standard 50mm jaws but the general technique is the same with other accessory jaws. However the maximum size of wood blank that can be mounted, the maximum turning speed and recess size varies with the different accessory jaws. Consult specific instructions included for each jaw set.

This is a strong holding method, using the standard 50mm jaws bowls up to 310mm (12 inches) in diameter can be turned. DO NOT EXCEED 600RPM WITH THIS OPERATION. OUT OF BALANCE STOCK MUST BE TURNED AT THE SLOWEST SPEED POSSIBLE.

**50mm jaws:** Any recess can be turned between 50mm (2 inches) and 70mm (23/4" inches) diameter.

Choose the diameter which suits your bowl design. However, bear in mind that best workholding will be achieved around 50mm - keep your recesses between 50mm and 60mm where ever possible. Extra care must be taken while turning with recesses above 60mm. The depth of the dovetail recess can be varied according to the size and mass of the workpiece. The larger bowl blanks or softer woods will require a deeper recess up to the maximum of 6mm (1/4 inch). HOWEVER YOU MUST USE THE MAXIMUM RECESS DEPTH ON ALL RECESSES OVER 64mm (2.5 inches) diameter OR ANY WORK WITH A DIAMETER OVER 150mm (6 inches).

For smaller lids and thin platters (not exceeding 150mm diameter) only a shallow recess of around 3mm (1/8 inch) is necessary. It will be a matter of gaining experience as to what combinations and sizes will suit best.

## FORMING RECESS

The jaw dovetail has been designed for use with a standard skew scraper. This chisel will make a recess to the angle required. FOR SAFETY REASONS WE STRONGLY ADVISE AGAINST USING ANY OTHER TOOL. A profile of this chisel is shown opposite. It is best to work with a tool which is already ground to the correct angle. All that is necessary then is to keep the leading edge of the chisel flat on the wood, moving forward and out to form the recess to the required diameter and depth.

Mount bowl blank on screw as described in previous section. It may be convenient to first mark out with a pencil, a circle on the bowl blank. To mark out the recess diameter with a pencil: hold pencil point to desired radius, supported on the toolrest. Then revolve blank by hand thus creating a pencilled circle. However, as specified above, any recess diameter can be made between 50mm (2 inches) - 75mm (3 inches) (standard 50mm jaws) so exact sizing of the recess is unnecessary.

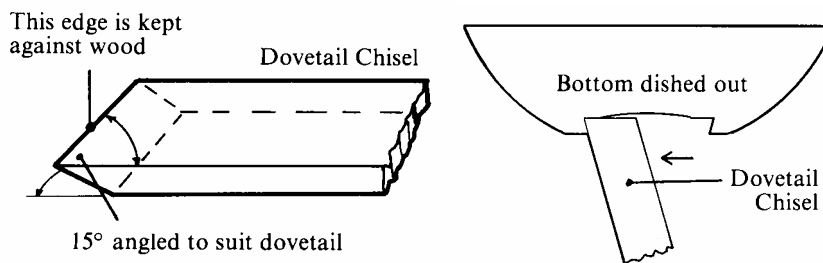

Before scraping out the recess, slightly hollow out the centre of the bowl blank with a bowl gouge or round nose scraper. The purpose is to relieve the centre so that when the recess is scraped out only half the chisel edge needs to be used. We recommend this to reduce tearing of the wood by scraping action; and to make the recess a little more finished to give a better effect to the overall bowl. Extra embellishments can also be made to the recess to enhance the bowl.

After the recess is finished and the outside of the bowl is turned to shape, wind bowl back off screw.

Bowl blank is now ready to be reversed onto the jaws. Using the lever in the scroll, expand the jaws into the recess. When the jaws are expanded out into the recess, screw the wood blank gently back and forth to make sure it is seated properly on the bottom face of the jaws.

**WARNING: MAKE SURE THE JAWS ARE SEATED PROPERLY IN THE RECESS AND THAT THE BOWL IS NOT INCORRECTLY REDING ON THE FLAT SHOULDER SECTION OF THE JAWS BEHIND THE DOVETAIL. THIS COULD LEAD TO THE BOWL DISLODGING FROM THE CHUCK. LOOSEN JAWS AND REMOUNT CORRECTLY**

Now give a few gentle raps with the end of a chisel handle or wooden mallet around centre of bowl. Use pinion handle to give an extra nip up. Refer to chuck operation on Page 4. Refer again to safety before operation.

## SPIGOT OPERATION

This is where the jaws contract around a wooden spigot for grip. This function is mainly for box, goblet and vase turning, that is, end grain items with a fair degree of overhang. This situation is one of the most difficult to provide secure holding no matter what fixing method is used. **EXTREME CAUTION WITH THIS OPERATION MUST BE EXERCISED. DO NOT EXCEED 850 RPM FOR THIS OPERATION.** If used properly the Nova chuck however, provides a very secure grip in this mode. Instructions below apply to the standard 50mm jaws but the general spigot technique is the same for other jaw types. However, maximum size of wood blank that can be mounted, maximum turning speed and recess size varies with different jaw types. Consult accessory jaw instruction sheet.

With the standard set of 50mm jaws a maximum size wood blank of 100mm (4 inches) diameter (NOT spigot size) by 150mm (6 inches) length can be turned. Square timber of same length and between 40mm (1.5 inches) to 50mm and grip all four jaws into wood. **MAKE SURE YOU HAVE AN ADEQUATE GRIP BEFORE OPERATION** by vigorously wrenching the limb mounted on chuck. If any loosening occurs **DO NOT PROCEED** with operation. Repeat tightening procedure and retest grip.

**SPIGOT SIZE:** Standard jaws will grip a round spigot between 45mm (1 49/64 inches) to 65mm (2 9/16 inches) approx. Square timber between 40mm (1 37/64 inches) to 50mm square approx. Jaw slides only: With the 50mm add-on jaws removed, the jaw slides will grip either round or square timber down to 8mm (5/16 inch). Length limits same for spigot work. Small work not greater than this diameter can be turned at a speed **NOT EXCEEDING 1800 RPM.** Larger work held in the jaw slides should not exceed 850 RPM.

**FORMING SPIGOT:** When selecting wood make sure it is sound without splits or weakness - especially around the area where the spigot is to be formed. **REMEMBER WITH FREE END TURNING, THIS IS THE ONLY AREA GRIP. IF ANY WEAKNESS IS FOUND, DO NOT PROCEED.**

Mount wood between centres and turn the spigot area. Make the spigot as parallel as possible to maximise the efficiency of the clamping action. Only approximate sizing of the spigot is necessary, as the jaws will accommodate a wide range of spigot diameters within the spigot limits stated above. The 50mm standard jaw has a thin lip or shoulder at the front face. This is designed to bite into the timber as the jaws are tightened. **DO NOT CUT A RECESS FOR THE LIP TO FIT INTO, AS THIS WILL REDUCE GRIPPING POWER.**

## TROUBLE SHOOTING GUIDE

FAULT	REMEDY
1. Insert jams when partially threaded into body	Check insert thread and chuck body thread are free from damage. Check insert has engaged with chuck body thread correctly. See 'Fitting to Chuck' Page 6. Make sure grubscrew has not been SCREWED IN.
2. Chuck body appears not to run true	Check insert is property home in chuck body. Check that the insert is correctly screwed onto lathe spindle. Insert must back against accurate face/register or bearing on lathe spindle. See Page 2.
3. 50mm Add on jaws do not run true	Check 50mm jaws are mounted correctly on jaw slides, For method see Page 9. For accuracy parameters see Page 2. When the jaws are expanded beyond a 50mm circle they will appear to be running out but in fact are maintaining concentricity. Always evaluate runout from turned wood clamped in jaws.
4. Jaw Slides closed to centre and No. 1 Slide stays in centre when jaws are expanded again	Jaw slide(s) have overtravelled from scroll. It will be necessary to tap back No.1 jaw slide until it has re-engaged. See Page 8 for 'insertion of jaws slides.'
5. Chuck very stiff to operate or jammed	See notes on chuck operation Page 4. Wood dust and shavings can clog the chuck in use. The chuck should be disassembled and cleaned. Follow instruction Page 4. Check grubscrew controlling action adjustment.
6. Jaw Slides when wound to centre do not meet	Slides have not engaged sequentially in clockwise order with scroll - 1- 2-3-4. Jaw slides could have been inserted out of order. Check insertion procedure Page 8.
7. When chuck is being removed from spindle the body unwinds from insert	Either lock insert in body using grubscrew and fibre washer provided or use insert spanner on the insert to wind chuck off lathe.
8. Chuck jams on lathe spindle	This is a common problem with fixtures on a lathe. To help prevent it try a plastic or fibre washer between insert/chuck and spigot shoulder of spindle. Greasing of insert face and spindle can also help - Note – Use of washer could affect accuracy.
9. Woodworm screw creeps forward or is not seated properly in chuck	Make sure woodworm screw boss is placed correctly between jaw slides and behind 50mm jaws. See Page 9.

<p>10. Wooden spigot shifts during turning</p>	<p>Check that the spigot area is made correctly for jaws to grip. Check that the spigot is not oversize. See spigot operation instructions Page 11. Use careful chisel techniques that do not exert too much pressure Irregular rough wood blanks need to be checked to see whether there is enough jaw contact.</p>
<p>11. Wood blank does not seat properly in internal dovetail mounting</p>	<p>Check the angle of the dovetail recess made is the same angle as the jaws. Make sure the bottom of the recess is flat and square to face. See dovetail operation Page 10. Check that the bowl is not incorrectly riding on the flat shoulder of jaws behind the dovetail.</p>

**Extra Support is available on our Website!**  
**Go to [www.teknatool.com](http://www.teknatool.com)**  
**or email [service@teknatool.com](mailto:service@teknatool.com)**

## SuperNova<sup>2</sup> Chuck Maintenance

This guide covers all steps, beginning from when your chuck is on the lathe; you may wish to skip several steps in order to advance to where you are currently at.

Tools needed: 1½" spanner  
Circlip pliers (and safety glasses)  
3mm Allan key (provided with Supernova 2 chuck)  
Plastic hammer (or block of wood)

Also you will need multi purpose grease for re-greasing chuck when re-assembling

### Removing The Supernova<sup>2</sup> from the Insert and Wood lathe

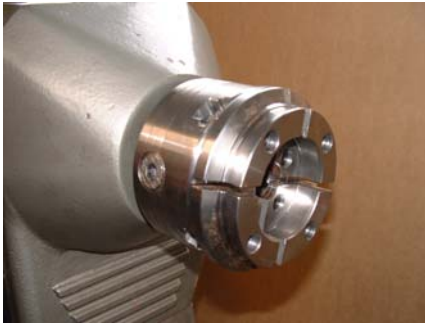

*The Supernova 2 chuck on a Nova 3000 DVR lathe*



*Removing grub screw to release insert*

Using the 3mm Allan key provided with the Supernova, release the M6 grub screw (turning in an anti-clock wise direction to loosen)



*Using 1 1/2" Spanner to remover chuck from lathe*



Using a 1½" spanner (like accessory 23014 pictured) undo the insert from the wood lathe. Make sure that the spindle lock on the lathe is engaged and with the spanner and block of wood or plastic mallet, exert enough force to move in an anti-clock wise direction

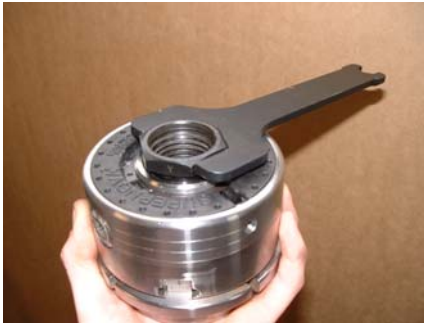

*Using 1 1/2" spanner to remover insert from chuck*

With the chuck in your hand and use the 1½" spanner again apply enough force to the spanner with a block of wood or plastic mallet to disengage the insert from the chuck

### **Disassembling the Supernova<sup>2</sup> Chuck**



*Using Circlip pliers to remove circlip*

Using the circlip pliers remove the circlip from the bottom of the chuck holding in the plastic backing. **YOU MUST WEAR SAFETY GLASSES WHILE PERFORMING THIS OPERATION AS THE CIRCLIP COULD POSSIBLY FLY IN AN UPWARDS DIRECTION**

Remove the M6 grub screw from the side of the chuck.



Screw in any Teknatool insert in the chuck thread. Engage the thread partially and tap on the back of insert with a mallet. You will see that the backing plate starts to come off. Remove the backing plate

Now using two flat head screw drivers gently push together to lift both sides of the plastic backing plate evenly. Do not try to force the backing plate out as this may damage the plastic plate. Remove the plastic backing plate completely thus exposing the pinions and back of the scroll ring.



*The Pinions can now come out by hand, as illustrated in the photo above.*



*Removing scroll ring from Chuck*

Turn the chuck upside down to remove the scroll ring



*Removing jaw slides by hand*

Now push manually push the jaw slides.

### **Maintenance of the Supernova<sup>2</sup> chuck**

Clean each of the four jawslide with a cloth removing any grit, wood, dust particles etc.

Clean the Scroll ring of all grease, grit, wood etc

Clean each of the two pinions of all grease, grit, wood etc

Re-grease the scroll ring and pinions; be very generous with grease application. (Normal multi purpose grease is sufficient)

If possible before re-assembling chuck blow out all parts with an air gun, if you do not have this carefully check that all parts are free of particles or debris.

### Re-assembling the Supernova<sup>2</sup> chuck

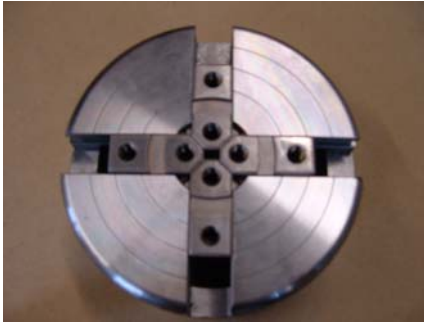

*Jaw slides forming a square in the center*

Push all jaw slides to meet in center forming a square. Make sure the No. 1 Jawslide is in the slideway with the dimple

Starting with Jawslide 1, insert jaws in clockwise direction in numerical order



*Moving scroll ring back and forth to seat it*

Place the scroll ring into the chuck and move it back and forwards with your fingers to seat it as shown in the above picture. You know once it has engaged as it will drop down and the pinions can now fit in. Make sure the jaws haven't moved and still have a square formed in the center



*Lining up backing plate with pinions*

Put the pinions in each of the two pinion holes. Like the scroll ring you may need to move it back and forward to engage it. Pinions must be all the way in otherwise the plastic backing cover will not go on. Position back plate to pinions like in the above picture and push down so that the plastic backing is flat with the chuck.



*Showing circlip snapped closed*

Place the circlip back on using the circlip pliers, you'll see that once the circlip is in its groove the two ends will snap together, see the above picture, you will notice that there is now only a small space between the two eye pieces of the circlip. **YOU MUST WEAR SAFETY GLASSES WHILE PERFORMING THIS OPERATION AS CIRCLIP MAY FLY UPWARDS OFF PLIERS**



*Using 1 1/2" spanner to re-attach insert.*

Using a 1 1/2" spanner wind back an insert, make sure that the spigot is in full contact with the back of the chuck. This is very important for maintaining accuracy. Once the insert is fully engaged screw in the M6 grub screw with the 3mm Allen key provided.

## SUPERNOVA<sup>2</sup> OPTIONAL ACCESSORIES

The SuperNova<sup>2</sup> Chuck is one of the most versatile chucking systems. It is fully compatible with the Nova Chuck, SuperNova<sup>2</sup> and Titan Chucks and shares the same extensive accessory range. You can use all the accessories on either your SuperNova<sup>2</sup> chuck, on your Nova Chuck or on your Titan Chuck. SuperNova<sup>2</sup> accessories include over 16 different jaw sets and other items to enable you to explore all areas of turning with your SuperNova<sup>2</sup> Chuck.

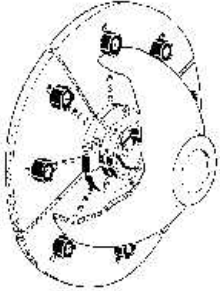
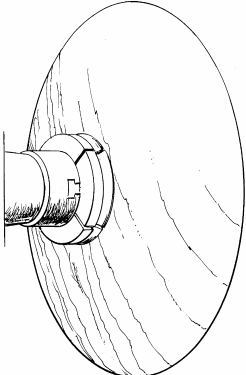
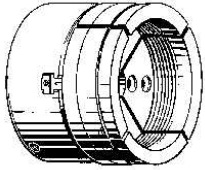
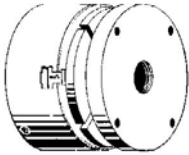
<p><b>COLE JAW SET Code: JSCOLE</b>  A versatile set designed primarily for rechucking of bowls to remove chuck marks or re-shape the bottoms of the bowls that have already been turned. Most other jaws etc can be mounted on top of the Cole Jaws for a combination jaw facility.</p>	
<p><b>130mm JUMBO JAWS Code: JS130N</b>  Essentially the big brother to the 100mm jaws these are designed to handle large work up to 750mm (29") in diameter, An ideal "companion" jaw to the SuperNova2 as the extra power of the SuperNova2 matches the big capacity of these jaws. No need to consider larger chucks for those special jobs - the Jumbo Jaws will perform just as well. Has a dovetail recess facility up to 149mm (5.86").</p>	
<p><b>POWERGRIP JAWS Code: PJSN</b>  These jaws have tremendous holding power. Best used in conjunction with the SuperNova, as the extra gripping power of the chuck enhances the PowerGrip's action. Able to hold large work up to 750mm (29") in diameter but has the added advantage over the 130mm jaws, of being able to hold long spigots up to 19" long. Also has a dovetail facility with up to 120mm (5") recess.</p>	
<p><b>VACUUM FACEPLATE Code: FPV</b>  Designed to fit onto the 50mm Jaws. This provides a faceplate facility to enable you to vacuum chuck. You provide a custom designed MDF/wood disk backed with foam- rubber to screw onto faceplate to seat bowls for vacuum chucking. Can be used in conjunction with Handwheel and Vacuum Coupler unit for our Nova 3000 or TL1500 wood lathes</p>	

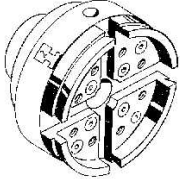
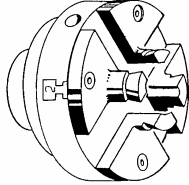
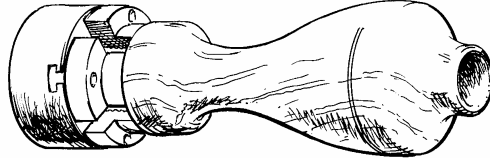
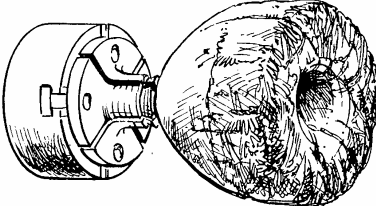
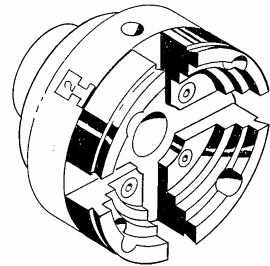
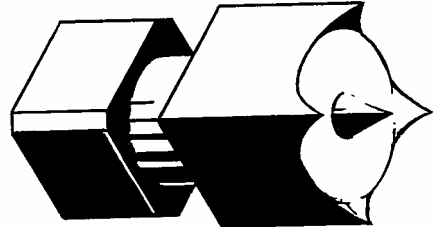
<p><b>100MM JAW SET Code: JS100N</b>        Have an expanding dovetail grip, strong reverse dovetail grip for footed bowls. Made for a larger range of work than either the 50mm or Step jaws.</p>	
<p><b>25MM JAW SET Code: JS25N</b>        Designed for small bowl (expanding dovetail mode) and small spigot (contracting mode) free end turning work below the size that can be handled by the standard 50mm jaws.</p>	
<p><b>35MM &amp; 45MM SPIGOT JAWS Code: JS-SP35 &amp; JS-SP45</b>        These two jaws provide a very powerful contracting spigot grip with the SuperNova2 Chuck. For long unsupported spigot turning applications.</p>	
<p><b>PIN JAW SET Code: JSPIN</b>        These special 25mm extended jaws are designed to act like a pin chuck - expanding into a pre-bored hole. This is a useful technique for free form edge bowls. The real advantage though is you don't have to bore an exact size as with pin jaws. The longer jaws allow for a very powerful spigot grip for smaller work like lace bobbins etc. It also has a small dovetail to mount small bowls.</p>	
<p><b>STEP JAW SET Code: JS75NDT</b>        Designed primarily to grip footed bowls in the contracting mode. Provides for optimum grip of three different size foot diameters. Also dovetail mode.</p>	
<p><b>SPUR CENTRE Code: NSCS</b>        This is a rugged 4 pronged spur drive with a 19mmsquare shank, which fits snugly into the SuperNova2 jaws. Creep of the spur is prevented as the shank is slotted to allow the chuck jaws to close over it. This spur is the answer for turners who use their SuperNova2 almost all of the time but want to be able to do those odd spindle jobs without removing the chuck from the lathe.</p>	

**INSERT SPANNER Code: 23014**  
Spanner to remove inserts off lathe spindle.

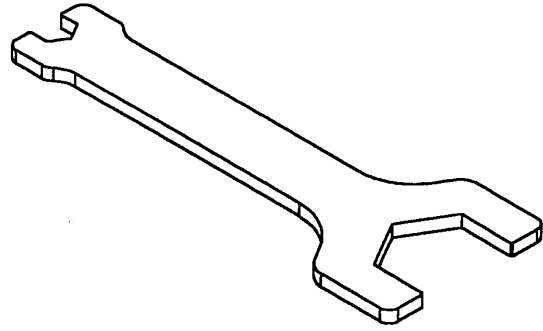

Other Accessories: Woodworm Screw RH & LH versions, Woodworm screws RH & LH for Cole Jaws,  
SuperNova/Nova Chuck Fastening Spares Kit, 100mm Jaws Fastening Kit.

**New Accessories are added all the time. For details on the latest,  
see your local Teknatool Reseller or our Website,  
[www.teknatool.com](http://www.teknatool.com)**

## WARRANTY

Your serial number is shown on your printed SuperNova<sup>2</sup> Quick Start Manual Sheet. For your future reference, record your serial number and warranty details here. For your convenience, you can also register your warranty online, simply go to [www.teknatool.com](http://www.teknatool.com)

### CUSTOMER TO COMPLETE

DATE PURCHASED:

STORE NAME AND LOCATION:

SERIAL NUMBER (from box):

This Teknatool Product is backed by a warranty period of twenty four months from the date of purchase. Teknatool International hereby agrees to make repairs or replace components without charge for any defects due to faulty material or workmanship, provided that

1. The warranty period has not elapsed. Proof of purchase date (sales slip etc) would need to be forwarded to Teknatool International Ltd.
2. If in our opinion the unit has not been altered, repaired or modified in any way that would affect its operation; has not been subjected to misuse, negligence, accident or not used strictly in accordance with instructions.
3. Where necessary transportation is prepaid by customer to Factory Service Centre, or other authorized Teknatool Service Centre.

Warranty does not cover any costs or damages arising directly or indirectly from the operation of this Teknatool Product. No other guarantee, written or verbal is authorized by Teknatool International Ltd.

INTERNATIONAL CUSTOMERS: Our Teknatool agents may issue their own Warranty in addition to our warranty policy, to cover this product. Their terms may vary from those stated above - please check with your dealer.

Our policy is one of continuous improvement. We therefore reserve the right to change specification/design without notice.

**You can register your warranty with TEKNATOOL  
International Online! Go to [www.teknatool.com](http://www.teknatool.com)**





**Teknatool International Ltd**  
65 The Concourse, Henderson,  
Auckland, New Zealand

Phone: 0064-9-837 6900  
Fax: 0064-9-837 6901  
[www.teknatool.com](http://www.teknatool.com)

Publication Code: 106-0502-003