



## 4240 10" Jointer Owner's Manual



## **Warranty**

Thank you for your purchase of a genuine Oliver woodworking machine. Oliver Machinery has made every attempt to provide a machine that is safe and durable.

All Oliver products are guaranteed, to the ORIGINAL RETAIL CUSTOMER, to be free from defects for TWO YEARS FROM THE DATE OF PURCHASE. Oliver Machinery will repair or replace, at its option, any component that fails under normal use. Please note that the customer is responsible for returning the failed component to Oliver Machinery prepaid for inspection.

This warranty does not cover damages caused by misuse, accident, unauthorized repair, alteration or improper maintenance.

## **Warning**

Read this manual thoroughly before operating the machine. Oliver Machinery disclaims any liability for machines that have been altered or abused. Oliver Machinery reserves the right to effect at any time, without prior notice, those alterations to parts, fittings, and accessory equipment which they may deem necessary for any reason whatsoever.

## **For More Information**

Oliver Machinery is always adding new Industrial Woodworking products to the line. For complete, up-to-date product information, check with your local Oliver Machinery distributor, or visit [www.olivermachinery.net](http://www.olivermachinery.net)

# , WARNING

Read this manual completely and observe all warning labels on the machine. Oliver Machinery has made every attempt to provide a safe, reliable, easy-to-use piece of machinery. Safety, however, is ultimately the responsibility of the individual machine operator. As with any piece of machinery, the operator must exercise caution, patience, and common sense to safely run the machine. Before operating this product, become familiar with the safety rules in the following sections.

- **Always keep guards in place and in proper operating condition.**
  - **Never reach around or under the jointer.**
1. **If you are not properly trained** in the use of a jointer do not use until the proper training has been obtained.
  2. **Read, understand and follow** the safety instructions found in this manual. Know the limitations and hazards associated with this machine.
  3. **Electrical grounding:** Make certain that the machine frame is electrically grounded and that a ground lead is included in the incoming electrical service. In cases where a cord and plug are used, make certain that the grounding plug connects to a suitable ground. Follow the grounding procedure indicated in the National Electrical Code.
  4. **Eye safety:** Wear an approved safety shield, goggles, or glasses to protect eyes. Common eyeglasses are only impact-resistant, they are not safety glasses.
  5. **Personal protection:** Before operating the machine, remove tie, rings, watch and other jewelry and roll up sleeves above the elbows. Remove all loose outer clothing and confine long hair. Protective type footwear should be used. Where the noise exceeds the level of exposure allowed in Section 1910.95 of the OSHA Regulations, use hearing protective devices. Do not wear gloves.
  6. **Guards:** Keep the machine guards in place for every operation for which they can be used. If any guards are removed for maintenance, **DO NOT OPERATE** the machine until the guards are reinstalled.
  7. **Work area:** Keep the floor around the machine clean and free of scrap material, saw dust, oil and other liquids to minimize the danger of tripping or slipping. Be sure the table is free of all scrap, foreign material and tools before starting to use the machine. Make certain the work area is well lighted and that a proper exhaust system is used to minimize dust. Use anti-skid floor strips on the floor area where the operator normally stands and mark off machine work area. Provide adequate work space around the machine.
  8. **Jointer position:** Position the jointer so that in case of material kick back the flying piece will not injure workers.
  9. **Material condition:** Do not attempt to joint boards with loose knots or with nails or other foreign material.
  10. **Operator:** Always use push blocks. Maintain a balanced stance and keep your body under control at all times.
  11. **Before starting:** Before turning on machine, remove all extra equipment such as keys, wrenches, scraps, and cleaning rags away from the machine and off the table.

12. **Careless acts:** Give the work you are doing your undivided attention. Looking around, carrying on a conversation, and “horseplay” are careless acts that can result in serious injury.
13. **Disconnect all power sources:** Before performing any service, maintenance, adjustments or when changing blades. A machine under repair should be RED TAGGED to show it should not be used until the maintenance is complete.
14. **Job completion:** If the operator leaves the machine area for any reason, the jointer should be turned "off" and the cutter head should come to a complete stop before leaving.
15. **Replacement parts:** Use only genuine Oliver Machinery factory authorized replacement parts and accessories; otherwise the warranty and guarantee are null and void.
16. **Misuse:** Do not use this Oliver jointer for other than its intended use. If used for other purposes, Oliver disclaims any real or implied warranty and holds itself harmless for any injury or damage which may result from that use.
17. **Drugs, alcohol and medication:** Do not operate this machine while under the influence of drugs, alcohol, or any medication.
18. **This machine is designed** for planing wood products only. Do not use to cut any kind of metal or substance other than wood.
19. **Never start the jointer** while a workpiece is in contact with the blade.
20. **Raise or lower the tables** only when the machine has been turned “off” and the cutter head has come to a complete stop.
21. **Make sure** the cutter head is running in the proper direction. The knives should be turning toward the infeed table.
22. **Health hazards:** Some dust created by power sanding, sawing, grinding, drilling and other construction activities contains chemicals known to cause cancer, birth defects or other reproductive harm. Some examples of these chemicals are:
  - Lead from lead-based paint.
  - Crystalline silica from bricks and cement and other masonry products.
  - Arsenic and chromium from chemically-treated lumber.Your risk from these exposures varies, depending on how often you do this type of work. To reduce your exposure to these chemicals, work in a well-ventilated area, and work with approved safety equipment, such as those dust masks that are specifically designed to filter out microscopic particles.

Familiarize yourself with the following safety notices used in this manual:

**CAUTION:** (This means that if precautions are not heeded, it may result in minor or moderate injury and/or possible machine damage)

**WARNING:** (This means that if precautions are not heeded, it could result in serious injury or possibly even death).

<b>Table of Contents</b>	<b>Page Number</b>
Warranty .....	2
Warnings .....	3-4
Table of Contents .....	5
Specifications .....	5
Uncrating the Machine .....	6
Contents .....	6
Machine Preparation and Setup .....	6
Dust Collection .....	7
Electrical Connections.....	7
Control Switch .....	7
<b>Fence</b> .....	8
Installation of the Fence .....	8
Fence Legend .....	8
Adjustment of the 90 Degree Stop.....	8
Fence Operation .....	8
<b>Knives</b> .....	9
Knife Removal.....	9
Knife Setting.....	10
Adjusting the Outfeed Table .....	10
<b>Spiral Head Option</b> .....	11
<b>Helical Head Option</b> .....	12
<b>Operation</b> .....	13
Hand Safety and Placement .....	13
Jointing .....	13
Direction of the grain .....	13
Edging .....	13
Facing.....	14
Beveling.....	14
Rabbeting.....	14
Adjusting the Infeed Table Height.....	15
<b>Maintenance</b> .....	16
V-Belts.....	16
Lubrication.....	16
Knives.....	16
Table Leveling.....	16
<b>Troubleshooting</b> .....	17

## Specifications

Model No. ....	4240
Stock No (3HP, 1PH, 220 Volt).....	4240.001
Stock No.(5HP, 3PH, 220/440 Volt, pre-wired 220 Volt) .....	4240.004
Stock No.(3HP, 1PH, 220 volt, <i>spiral head</i> ).....	4240.101
Stock No (5HP, 3PH, 220/440 volt, pre-wired 220 Volt, <i>spiral head</i> ) .....	4240.104
Infeed Table Travel (in.) .....	5/8
Cutterhead speed (RPM) .....	5000
Number of Knives (Straight).....	4
Number of Knives (Spiral).....	3
Rabbeting Capacity (in.).....	5/8
Dust Port Diameter (in.) .....	6
Table Dimensions (L x W/in.).....	84 x 11
Table Height (In.) .....	30-1/2
Fence Dimensions (L x H/in.).....	52 x 4-7/8
Fence Tilts (deg.) .....	90 - 45
Positive Stops (deg.).....	90 and 45
Shipping Dimension (L x W x H/in.) .....	91 x 31 x 38
Overall Dimensions .....	84 x 30 x 37
Gross Weight (lbs.) .....	900
CFM.....	885CFM at 4500FPM air velocity

## Oliver 4240 – 10” Jointer

### Uncrating the Machine

The machine should arrive as show in Figure 1. Uncrate the machine and inspect the unit for signs of shipping damage. If damage is found, contact your dealer immediately. Unbolt the machine from the pallet. Retain all packaging materials in case it becomes necessary to ship the machine to another site.

### Contents: (Figures 2 & 3)

1. 10” Jointer
2. Fence assembly
3. Blade guard
4. Fence attachment bolt
5. Knife Setting guage
6. Two wrenches
7. Allen key

### Machine Preparation and Setup

**, WARNING!**  
The equipment used to lift this machine must have a rated capacity at, or above the weight of the jointer. Failure to comply may cause serious injury!

The jointer must be positioned on a smooth, level surface. The area must be well lit and have plenty of room to maneuver with large pieces of wood.

Level the jointer front to back and side to side using a level placed on the table. Use shims under the corners, if necessary, but make sure the jointer is stable before being placed into service.

Clean all rust protected surfaces with a commercial solvent. Do not use acetone, gasoline, lacquer thinner or any type of flammable solvent, or a cleaner that may damage paint. Cover cleaned surfaces with WD-40 or a 20W machine oil.

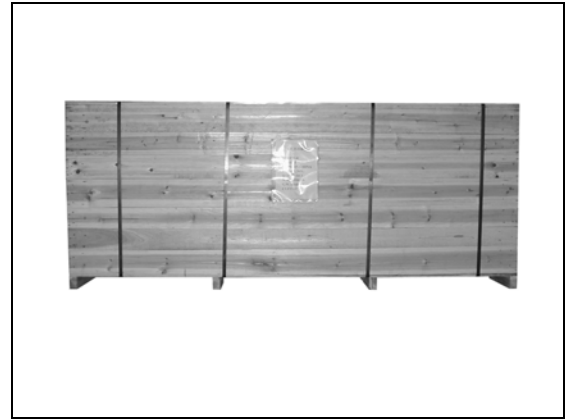

Figure 1

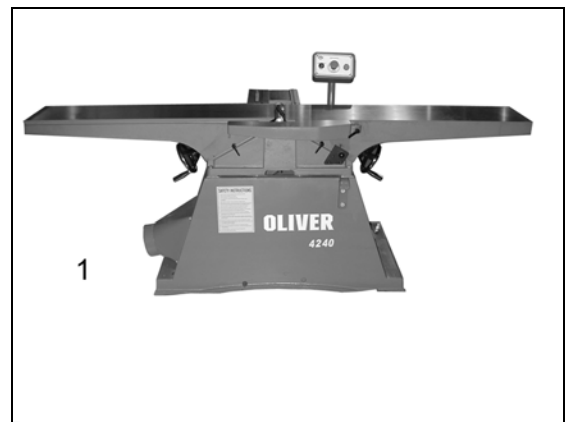

Figure 2

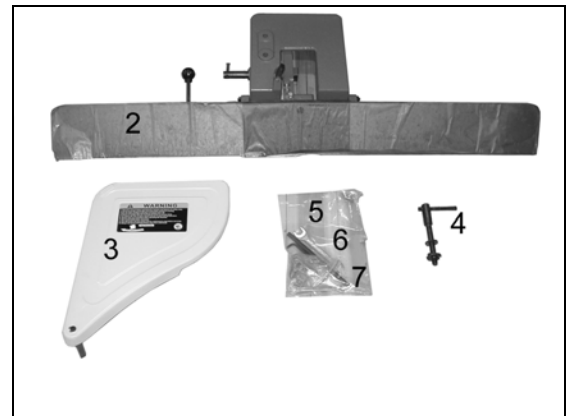

Figure 3

## Dust Collection

The 6" dust collection port (A, Figure 4) is located below the outfeed table. Typically flex hose is used to run from this point to a central trunk line.

*Note: Do not operate the jointer without dust collection.*

## Electrical Connections

### **WARNING!**

**Electrical connections and wiring must be performed by a certified electrician. The machine must be properly grounded. Failure to comply may cause serious injury!**

This jointer can be 1 or 3-Phase based on your order and is wired for 220 volt. If on 3 phase you need to switch from 220V to 440V, have a certified electrician make the changes. As well, a step down control transformer will have to be installed.

For 3 phase machines, bring your incoming power leads up through the bottom right hole of the case and tie to L1, L2, L3 as shown in Figure 5. Then tie your earth ground to the ground connection in the box.

For 1 phase machines, tie your incoming power leads to L1 and L3.

Make sure the voltage of your power supply matches the specifications on the motor plate of the machine.

With 3-Phase power verify the cutter head is turning in the proper direction. If rotation is incorrect, swap two of the phases to reverse.

*Note: If running from a phase converter ensure the 'high leg' of the converter does not feed the control circuit.*

## Control Switch

For shipping purposes the control switch is mounted as shown by 'A' in figure 6. Remove the two mounting bolts and reposition the switch as shown by 'B' while re-securing using the two bolts.

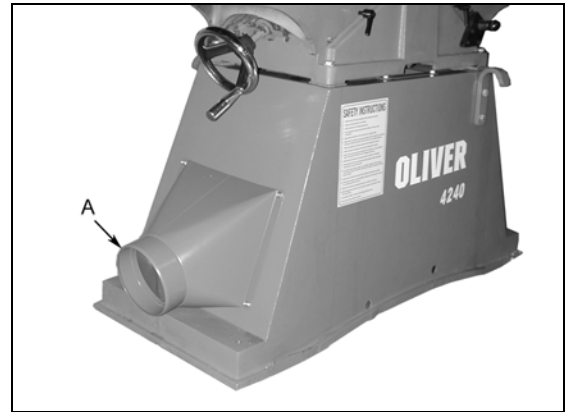

Figure 4



Figure 5 (3 Phase)

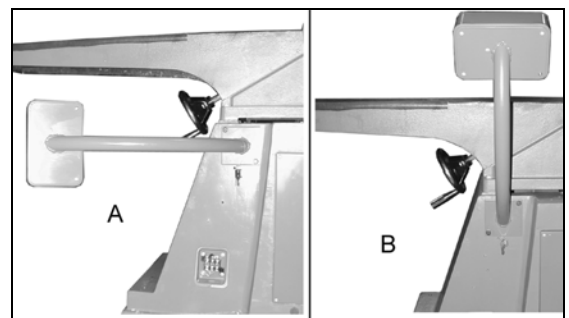

Figure 6

## Fence

**, WARNING!**  
Never make any adjustments with the machine running!

### Installation of the Fence

The fence, although completely assembled, requires bolting to the machine.

1. Set the fence bracket (Figure 8) on top of the fence support bracket (Figure 7) lining up the key slides 'A' with the guides on the bottom of the fence bracket. Install the width lock handle and special washer with the tabs facing up into the slot of the fence support bracket. For rabbeting the handle should be inserted into the rear hole as shown in Figure 8.

### Fence Legend

The various adjustments, locks and handles are shown in Figure 8.

- A. 90 degree adjust bolt.
- B. Angle lock handle.
- C. 90 degree flip stop.
- D. 45 degree adjust bolt.
- E. Width lock handle.
- F. Fence angle adjust handle.

### Adjustment of the 90 Degree Stop

1. Lay a square on the infeed table as shown in Figure 9.
2. Loosen the angle lock handle (B, Figure 8).
3. Ensure the 90 degree flip stop (C, Figure 8) is in the 90 degree position.
4. Loosen the jam nut on the 90 degree adjusting bolt (A, Figure 8) and adjust the bolt against the flip stop until the fence becomes true with the square.
5. Tighten the jam nut while holding the bolt in position.

### Fence Operation

To tilt the fence, see Figure 8. Loosen angle lock handle 'B', flip up the stop 'C', and tilt the fence with the fence angle adjusting handle 'F' to the desired angle. Use a protractor or adjustable triangle to set the angle. A 45 degree stop, 'D' is provided for quick set-up at this angle.

To adjust the cutting width loosen the lock handle 'E' and move the fence to the desired position. .

Once any adjustments are made be sure to lock them into place before jointing.

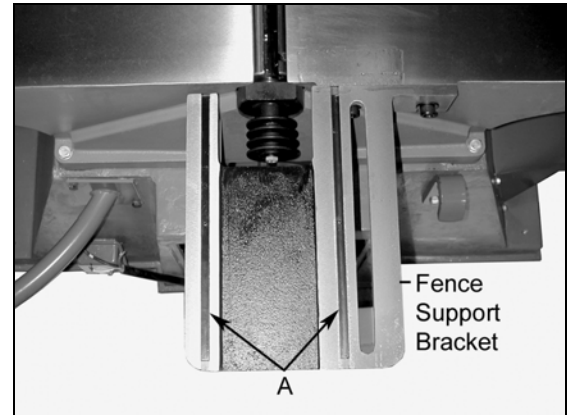

Figure 7

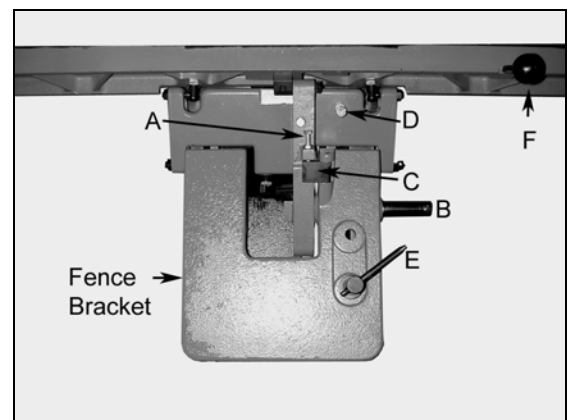

Figure 8

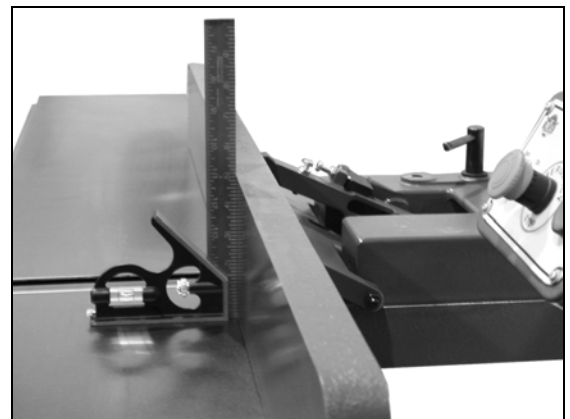

Figure 9



## Knives

### **, WARNING!**

The knives are extremely sharp. Use caution when handling.

#### Knife Removal

1. To expose the cutterhead, move the fence all the way back.
2. Back down both the infeed and outfeed tables to their lowest position. Be sure to loosen the lock on both the infeed and outfeed tables before doing so.
3. Now turn the cutterhead by hand until one of the knives is exposed and accessible. Use gloves or a rag to prevent injury.
4. Using a 8mm wrench on the knife lock bolt, release the pressure on the knife by turning the bolt into the cutterhead as shown in Figure 10. To prevent injury, hold the wrench with one hand while tapping the top of the wrench with the other hand as shown. Do this for all six bolts.
5. Once all the bolts have been turned in remove the knife.

#### Knife Setting

Your 10' jointer is equipped with both jack screws or springs to aid in knife setting. It is your choice which method you use.

Method 1: Springs (when using the spring method make sure the jack screws are turned down and out of the way)

**Note:** It is not only important to set the height of the knife with respect to the cutterhead it is also important that the outside edge of the knives be aligned with the rabbeting ledge.

1. With the knife in the slot use a straight edge on the rabbeting ledge as shown in Figure 11 to push the knife into alignment with the edge.
2. Next use the supplied knife gauge as shown to carefully push down on the knife until it is position as shown in Figure 12. Make sure the knife makes contact within the indent as shown by 'A' in Figure 12.
3. With the knife held firmly into place back the knife lock bolts out into the cutterhead in order to put pressure onto the knife. Work from the center bolts outward. Do this in two steps. First loosely, then firmly the second time.
4. Repeat the above for all knives.

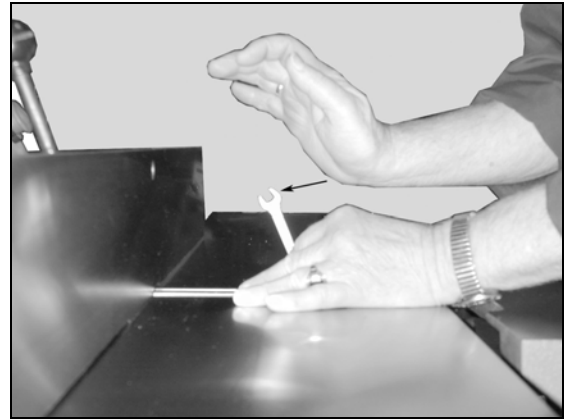

Figure 10

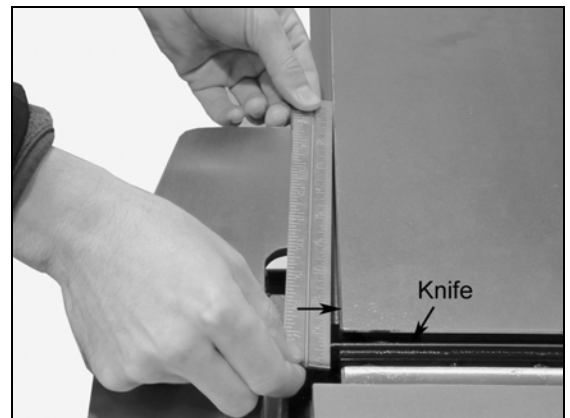

Figure 11

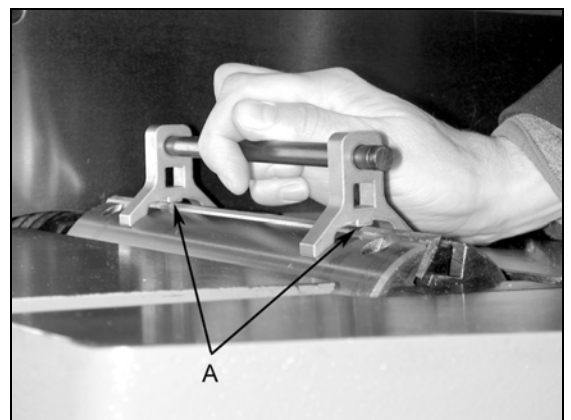

Figure 12

## Knife Setting (cont.)

### Adjusting the Outfeed Table

1. Once the knives are set it is now time to set the outfeed table. For proper operation the height of the outfeed table must be set to the highest point of the cutting circle. To do this, set a straight edge on the outfeed table as shown in Figure 13.
2. Carefully adjust the table height by turning the handwheel (A, Figure 14) while rocking the cutterhead back and forth as shown by the arrow in Figure 13. The table will be at it's correct height when the knife, at it's highest point of the cutting circle, just scrapes the bottom of the straight edge.
3. Once set, lock into place with the height lock knob (B, Figure 14).

**Note:** Failure to adjust the outfeed table will result in either a curved or sniped work piece.

Method 2: Jack Screws (when using this method remove the springs and place in storage)

*Note:* As described in the previous method, align the knives with the rabbeting ledge.

1. With the knife in the slot, turn the jack screws using an allen key (Figure 15) so that the bevel plus an additional 1/32" of knife is protruding from the cutterhead. Note that this 1/32" need not be exact.
4. Next set a straight edge on the outfeed table as shown in Figure 15 and adjust the outfeed table height with the handwheel (A, Figure 14) so that it is level with the knives
5. When properly adjusted, the knife should just scrape the bottom of the straight edge at it's highest point of it's cutting circle. Use the jack screws to finely adjust the knife height at both ends.
6. Once the knife is at the correct height back the knife lock bolts out into the cutterhead in order to put pressure onto the knife. Work from the center bolts outward. Do this in two steps. First loosely, then firmly the second time.
7. Repeat the above for all knives.

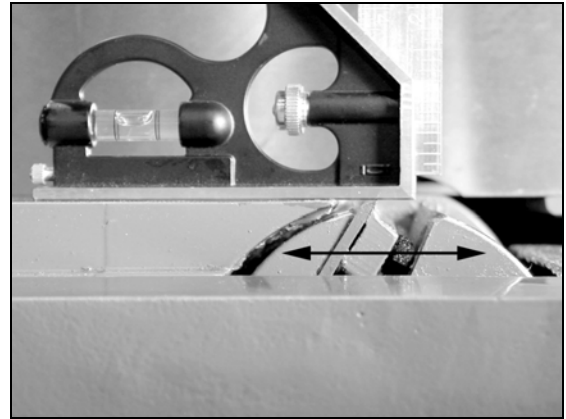

Figure 13

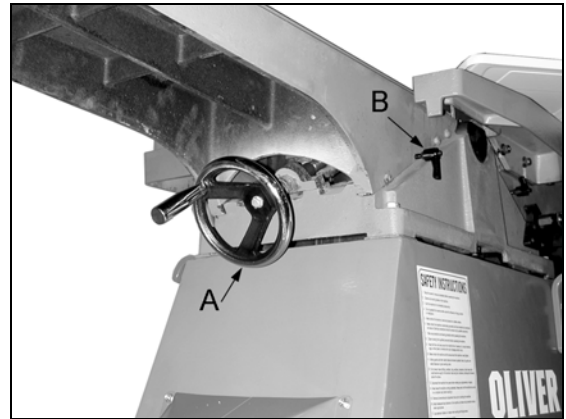

Figure 14

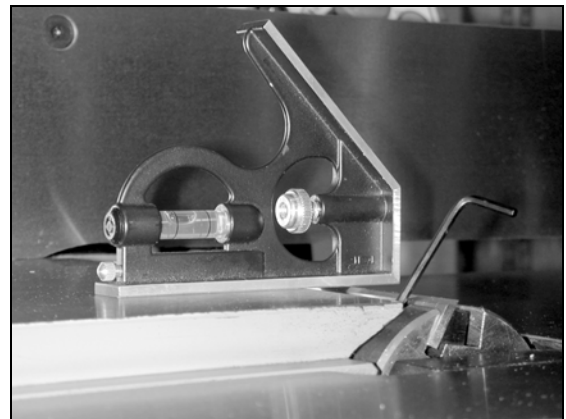

Figure 15

### Spiral Head Option

If you purchased a machine with the spiral cutterhead (Figure 16), instructions for replacing the knives are as follows.

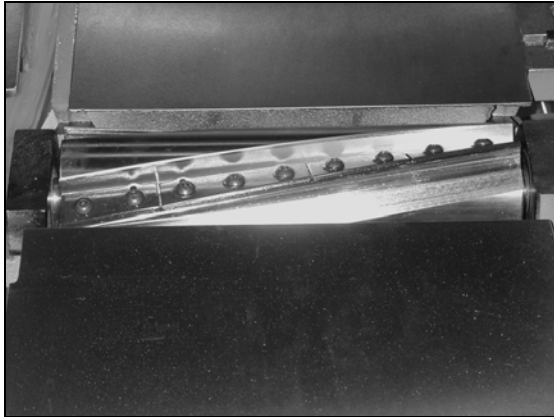

Figure 16

1. Using an allen key, remove all the screws 'A', gib plates 'B', and knife 'C' as shown in Figure 17.

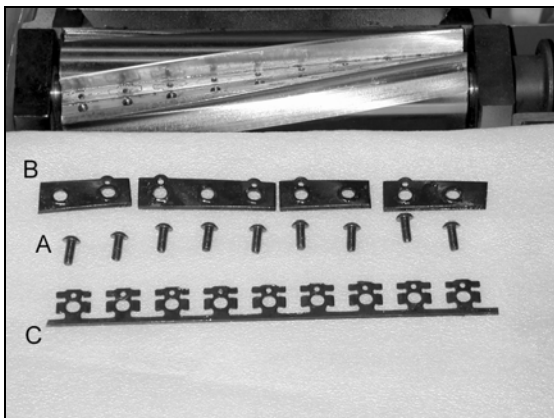

Figure 17

2. Set the new knife on the cutterhead as shown in Figure 18 by lining up the knife tabs 'A' in the slot and the index holes 'B' with the holes in the cutterhead.

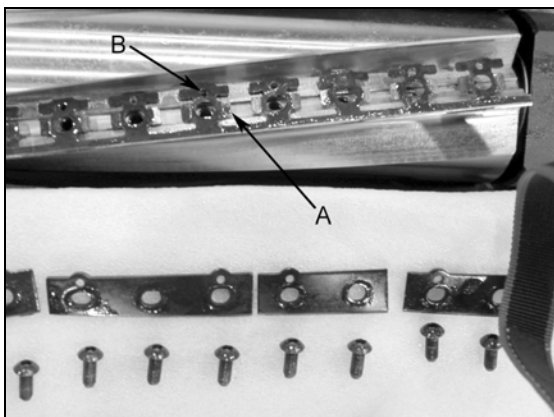

Figure 18

3. Starting in the middle of the knife, place the gib plate on the knife and lightly screw in one of the gib screws so that the knife tab seats in the slot. Figure 19



Figure 19

4. Begin installing the rest of the gib plates using the indexing tool (A, Figure 20) to properly align the knife while tightening the screws.

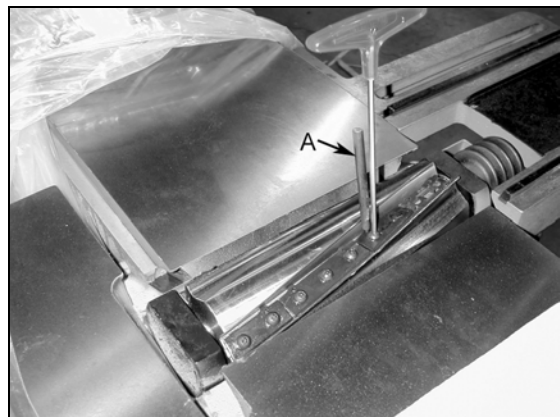

Figure 20

5. Repeat the above procedure for all the knives while making sure to firmly secure all screws.
6. Set the outfeed table as described on page 10.

## Operation

### **, WARNING!**

Keep all guards in place. Keep hands away from the cutterhead! Always use push stick when possible. Failure to comply may cause serious injury.

### Hand Safety and Placement

Never pass the hands directly over the cutter knife. As one hand approaches the knives remove it from the stock in an arc motion and place it back on the stock in a position beyond the cutter knife. See Figure 21.

When feeding the work piece, pressure is applied not only toward the cutterhead but against the fence and down to the table as well. At the start of the cut, the left hand holds the material down and toward the fence while the right hand pushes toward the cutterhead. As the material crosses the cutterhead the left hand comes up and over as in Figure 21 to continue the pressure but now on the outfeed table. As the right hand approaches the cutterhead it is time to move it up and over the cutterhead in the same fashion as the left in Figure 21 all the while continuing pressure as stated above.

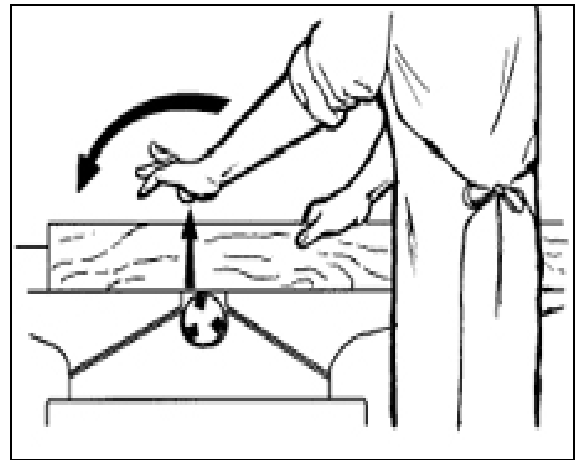

Figure 21

### Jointing

In order to craft a good woodworking project, it is necessary to have a square piece of wood to start with. The way to do this is with a jointer. You need one straight edge and one flat face. After you have these, you can plane to thickness and rip to width and the resulting piece will be square and true on all four sides. At this point you can begin building your project.

### Direction of the Grain

To avoid tear out, always feed the material in the direction of the grain. If the direction of the grain changes half way through the board, try taking lighter cuts at a slower feed rate. If the results are still unsatisfactory, try turning the material around and feeding the other way. (Figure 22)

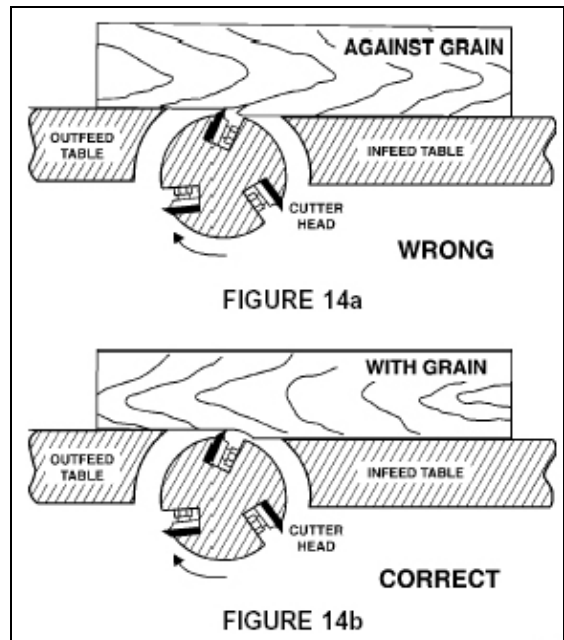

Figure 22

### Edging

To give a good straight edge for gluing or joining, set the fence square with the table. Remove the least amount of material required to obtain a straight edge. Hold the best face of the piece firmly against the fence throughout the feed. When finished you will have a perfect starting point for your project. (Figure 23)



Figure 23

## Facing

Once you have a good edge it is time to eliminate any warp or cup on the board. Keep in mind the outfeed table is the reference point and once the material is past the cutterhead, downward pressure should be applied to the outfeed table only. Putting downward pressure on the board over the infeed table will bend any cup or warp prior to hitting the cutterhead and after the pressure is released, the cup will spring back. At the same time try keeping a constant feed rate in order to give a good smooth cut with no burn marks. (Figure 24)



Figure 24

## Beveling

For beveling (Figure 25), set the fence to the desired angle using a protractor and lock into place. Feed the material through pressing firmly against the fence and tables. Several passes may be necessary for the desired result.



Figure 25

## Rabbeting

**, WARNING!**  
Rabbeting requires removal of the blade guard. Use extreme caution and replace the guard after completion.

1. Adjust the fence so that the distance between the edge of the knife and the fence is equal to the width of the desired rabbet (Figure 26).
2. Lower the infeed table to the depth of the rabbet required. If the rabbet is quite deep it may be necessary to do it in increments.



Figure 26

### Adjusting the Infeed Table Height

The height of the infeed table with respect to the cutting circle will determine the amount of material to be removed from the work piece. To raise or lower the table, turn the height adjusting wheel (A, Figure 27) below the infeed table to the desired height indicated by the gauge (C, Figure 27). For optimum performance and safety your jointer has a stop pin (B, Figure 27) to limit the amount of material removal to 1/8" per pass. However, if a heavier cut is required, the pin can be pulled out and the table adjusted to the desired depth.

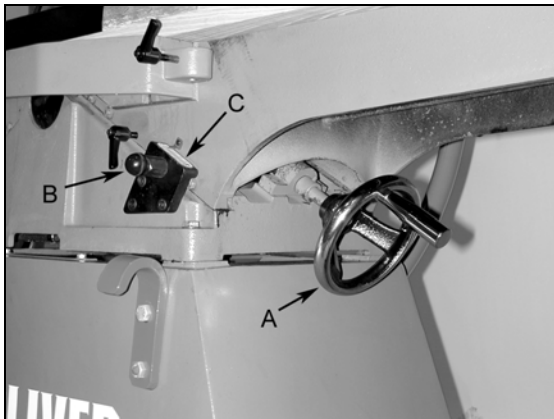

Figure 27

## Maintenance

### V-Belts

After the first 20 hours of operation it is necessary to check the tension on of the V-belts. To do this, open the access panel (A, Figure 28) by removing the four corner screws. With medium finger pressure the belt should push in approximately  $\frac{1}{2}$ " about midway between the pulleys. If there is too much play, adjust the tensioning bolts (A, Figure 29). First loosen the two nuts (not shown in the picture) underneath the motor bracket and then turn down the top nuts to increase the belt tension.

### Lubrication

Periodically apply a light grease to the tables up/down lead screw. As well, apply a light oil to the dovetail ways from time to time to allow ease of movement.

The cutterhead bearings are permanently greased for life and do not require care.

### Knives

When knives become gummed up with pitch carefully clean them with a strong solvent. A knife in this condition will not only give a poor cut it will allow heat to build up quickly thus putting undue stress on the machine.

Dull knives can be replaced or sharpened. Check in your local yellow pages for a sharpening service. It may be more cost effective to replace rather than sharpen.

*Note; Do not run the machine with dull knives. Not only will they give a bad cut, they put undue stress and vibration on the machine thereby decreasing the life of the machine and damaging the cutterhead bearings.*

### Table Leveling

Over time the table gibs will wear causing the tables to become un-parallel. At this time it becomes necessary to tighten the gibs using the set screws (A, Figure 30). First loosen the jam nuts and then turn in the set screws until they make good contact with the gibs. Tighten the jam nuts.

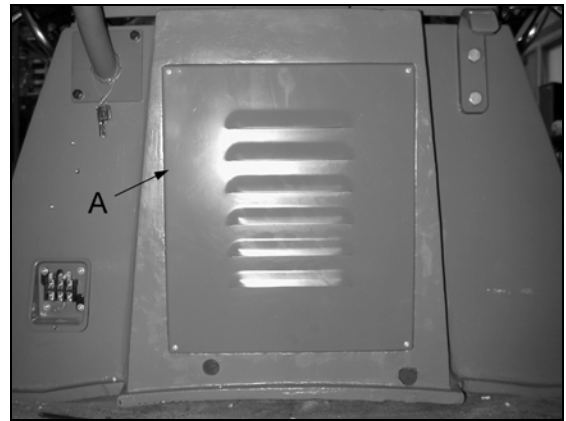

Figure 28

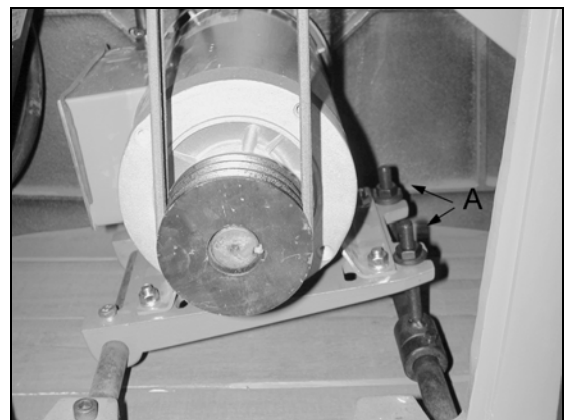

Figure 29

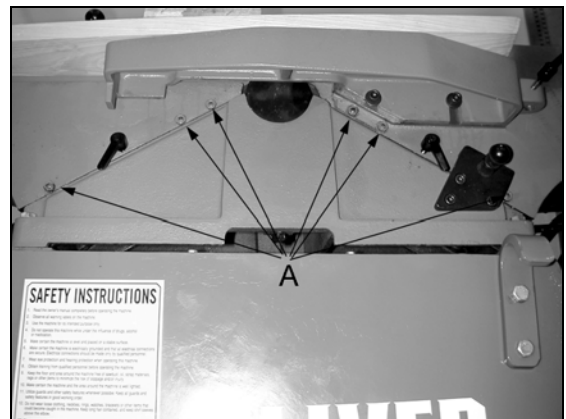

Figure 30

## Troubleshooting

Description of Symptoms	Possible Cause	Corrective Action
Machine will not start	<ol style="list-style-type: none"> <li>1. Fuse blown or circuit breaker tripped</li> <li>2. Cord Damaged</li> <li>3. Faulty switch</li> <li>4. Not connected to power source</li> <li>5. No power to machine</li> <li>6. Emergency stop button pressed</li> </ol>	<ol style="list-style-type: none"> <li>1. Replace fuse or reset circuit breaker</li> <li>2. Have cord replaced</li> <li>3. Replace switch</li> <li>4. Check connection</li> <li>5. Check voltage</li> <li>6. Rotate emergency stop button clockwise until it pops out</li> </ol>
Cutterhead does not come up to speed	<ol style="list-style-type: none"> <li>1. Cable too light or too long</li> <li>2. Low current</li> <li>3. Motor not wired for correct voltage</li> </ol>	<ol style="list-style-type: none"> <li>1. Replace with adequate size cable</li> <li>2. Contact local electric company</li> <li>3. Refer to motor nameplate for correct voltage</li> </ol>
Unsatisfactory finish	<ol style="list-style-type: none"> <li>1. Dull Knives</li> <li>2. Gum or pitch on knives</li> </ol>	<ol style="list-style-type: none"> <li>1. Sharpen or replace knives</li> <li>2. Clean or replace knives</li> </ol>
Excessive vibration	<ol style="list-style-type: none"> <li>1. Machine not level.</li> <li>2. Damaged knives</li> <li>3. Bad V-belts</li> <li>4. Bent pulley</li> <li>5. Improper motor mounting</li> <li>6. Loose hardware</li> </ol>	<ol style="list-style-type: none"> <li>1. Reposition on flat, level surface</li> <li>2. Replace knives</li> <li>3. Replace V-belts</li> <li>4. Replace pulley</li> <li>5. Check and adjust motor</li> <li>6. Tighten hardware</li> </ol>
Adjustments do not move freely.	Sawdust and debris in mechanisms	Clean and regrease
Finished stock is concave on the end	Knife is higher than the outfeed table	Adjust the outfeed table to the highest point of the cutting circle
Back end of the stock is thicker than the front end	Knife is higher than the outfeed table	Adjust the outfeed table to the highest point of the cutting circle
Finished stock is concave or convex in the middle	Tables are not level with each other.	Level one of the tables to the other.